

TIMKEN**The Timken Company**

4500 Mt Pleasant St. NW

N. Canton, OH 44720

Phone: (234) 262-3000

E-Mail: CustomerCAD@timken.com • Web site: www.timken.com

Part Number 3201 ATN1, Timken® Double Row Angular Contact Ball Bearings (3200, 3300)

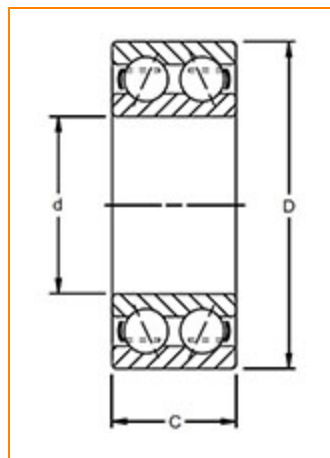
[Dimensions](#) | [Specifications](#) | [Basic Load Ratings](#) | [Abutment and Fillet Dimensions](#)

Dimensions

d - Bore	12.00 mm 0.4724 in
D - Outer Diameter	32.00 mm 1.2598 in
C - Ring Width	15.9 mm 0.6260 in
Contact Angle	30°

Specifications

Features	Open
Ball Type	STEEL
Age Type	Molded



Cage Material	Nylon
Bearing Weight	0.06 Kg 0.128 lb
Design Units	METRIC

Basic Load Ratings

C0 - Static Radial Rating	5200 N 1169 lbf
C1 ISO - Dynamic Radial Rating	9400 N 2113 lbf

Abutment and Fillet Dimensions

R - Inner Ring "To Clear" Radius ¹	0.60 mm 0.024 in
r - Outer Ring "To Clear" Radius ²	0.60 mm 0.024 in
da - Inner Ring Backing Diameter	16.4 mm 0.646 in
Da - Outer Ring Backing Diameter	27.6 mm 1.087 in

¹ Maximum housing fillet radius that bearing corners will clear.

² Maximum shaft fillet radius that bearing corners will clear.

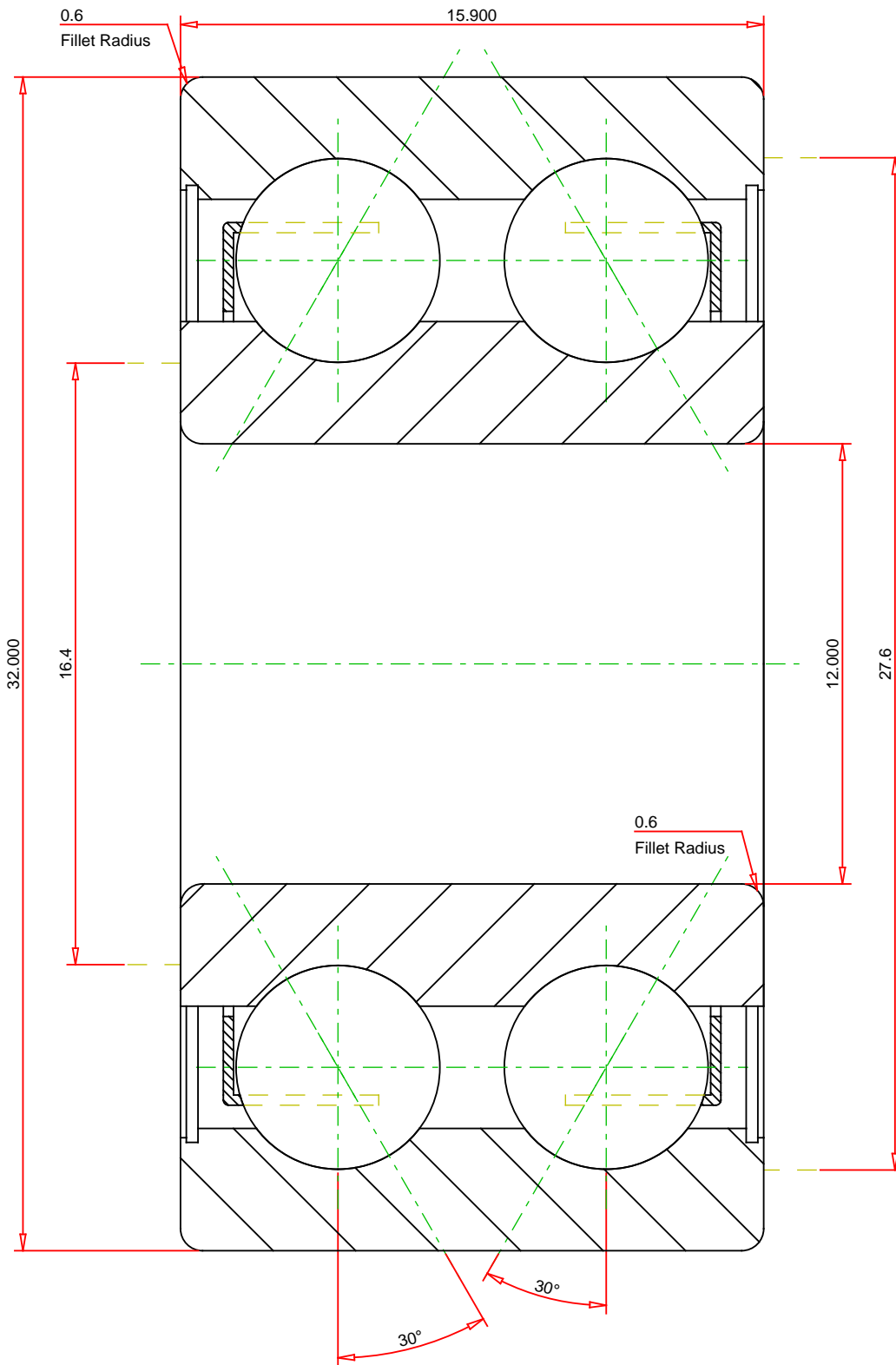

METRIC UNITS

Number of Balls Per Row	7
Bearing Weight	0.060 kg

TIMKEN®

THE TIMKEN COMPANY
NORTH CANTON, OHIO USA

3201 ATN1	
Timken® Double Row Angular Contact Ball Bearings (3200, 3300)	
Dynamic Load Rating	9400 N
Static Load Rating	5200 N

Every reasonable effort has been made to ensure the accuracy of the information contained in this writing, but no liability is accepted for errors, omissions or for any other reason.

FOR DISCUSSION ONLY